

DOPAK® Process Sampler Type S32

back and needle purge configuration
with venturi unit (E4)

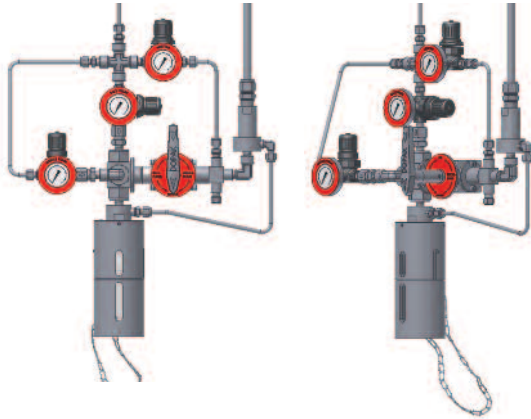

The ability to create an under pressure in the sample bottle by a venturi unit ensures optimal retrieval of a representative, contamination free sample from processes at vacuum conditions or atmospheric pressure. The S32 type of sampler in back & needle purge configuration allows a gas to purge the sampler and process connection prior to sampling ensuring a fresh sample and allows purging through the needle assembly. All S32 type of samplers offer a one-handle operation by multiple valves.

1 OPERATION/FUNCTION

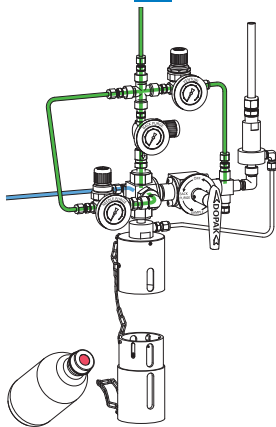

0 - off

Provide a new septum on your sample bottle. Insert the bottle, with cap and septum into the bottom part of the bayonet sleeve. Connect the bottom part of the bayonet sleeve to the upper part, move the bottom part upwards and lock it by turning it in the slot in the top end position.

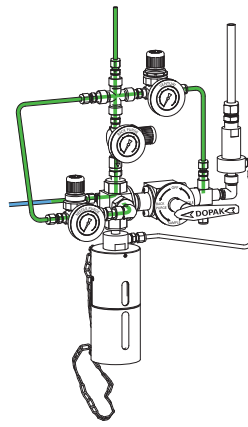

1 - back purge

Turn the handle to the "back purge" position, allowing a flow of purge gas through the sampler to the process to ensure representative sampling. This position can be held for any required time.

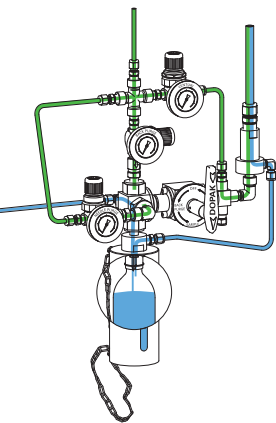

2 - sample

Turn the handle to the "sample" position, allowing the purge gas to flow through the venturi unit to create an under pressure in the sample bottle. The product flows into the sample bottle. When the required amount has been taken, turn the handle to the "needle purge" position.

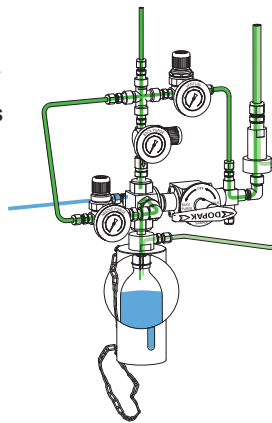

3 - needle purge

In this position a flow of purge gas is allowed to go through the sampler to ensure any residual liquid is forced into the sample bottle. This position can be held for any required time.

2 TYPICAL P & ID

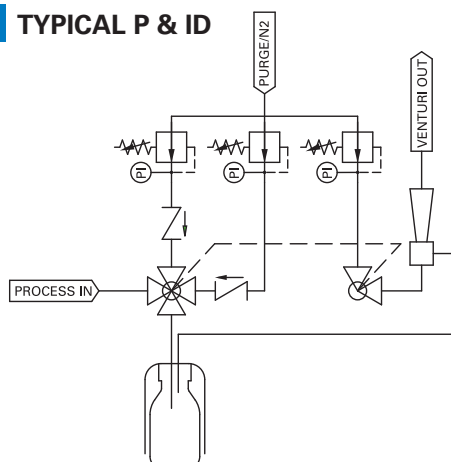

Back / needle purge - venturi (E4)

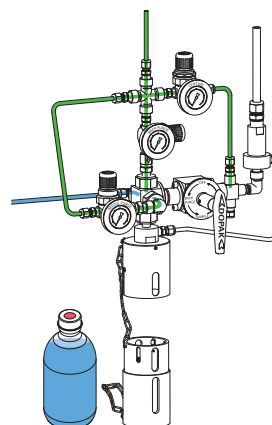

4 - off

Turn the handle to the "off" position. Move the bottom part of the bayonet sleeve slightly upwards, turn it and pull it out from the upper part. The septum reseals automatically. Take the bottle out from the bottom part of the bayonet sleeve.



3 FEATURES/ADVANTAGES/PROPERTIES

- Sampling directly under process conditions
- Atmospheric and vacuum applications
- Representative sampling
- Zero dead volume
- Closed sampling

4 BASIC SPECIFICATIONS

Material	SS316, SS316L.
Sleeve type	60cc bayonet sleeve.
Needle assembly	Single piece VTO needle assembly with TTC ring and vent to outlet connection 1/4" FNPT. Process/vent needle ID: 1.35 mm.
Valves	Process: Four-way ball valve type H7911. PTFE seats, Viton A packing. Pressure range 103 bar @ 20°C (1500 psig @ 70°F). Temperature range -18/+177°C (0/+350°F). Vent: Two way ball valve type W43. PTFE seats. Pressure range 206 bar @ 20°C (3000 psi @ 70°F).
Operation	Manual by gearbox.
Connections	1/4" FNPT, regulators, gauges and check valves included.
Please note:	the above is a basic specification only. DOPAK® Samplers can be offered with a wide variety of options as mentioned below.

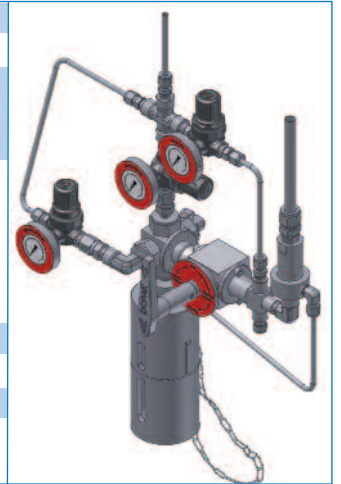

5 OPTIONS

- Fixed sequence handle
- Lockable handle
- Mounting plate
- Pipe stand
- Block valve
- Flow meter
- Enclosure
- Sample cooler
- Mounting bracket
- Steam sterilising cap
- Welded connections
- Exotic materials
- Larger/smaller sample size

For more information please refer to our sheets:

Options for DOPAK® process samplers, sampling into a bottle.

Components for DOPAK® process samplers.

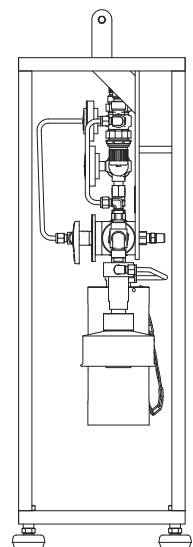
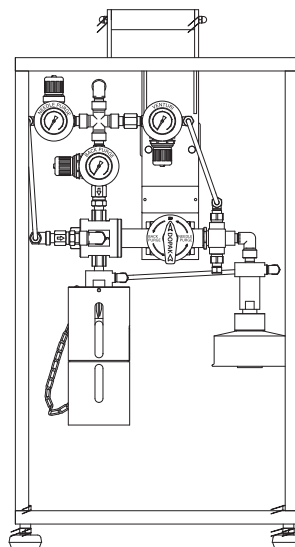
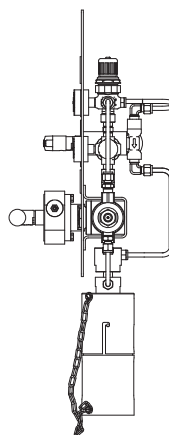
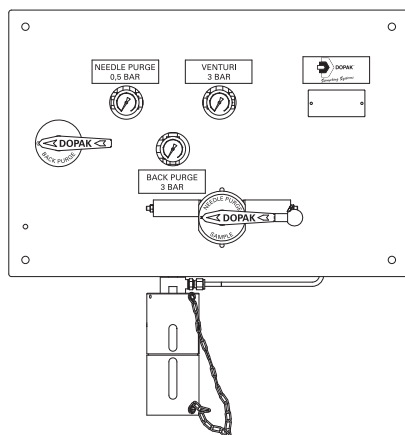

Dopak PFT Corp.

Houston, Texas 77041, USA

Phone 713-460-8311

Fax 713-460-8578

E-mail info-dopak@cranecpe.com

Dovianus BV

Bergschenhoek, The Netherlands

Phone +31 10 524 20 00

Fax +31 10 524 20 29

E-mail info-dovianus@cranecpe.com

Your local distributor

