

The ability to purge the sample point ensures optimal retrieval of a representative, contamination free sample. The S32 type sampler provides a system purge and needle purge in addition to a fixed sample. The unique design offers a one handle operation by multiple valves, allowing for sampling independent of the process conditions. These features provide sample accuracy and safety.

1 OPERATION/FUNCTION

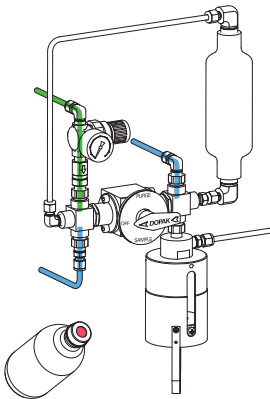

0 - off
Provide a new septum on your sample bottle. Insert the bottle, with cap and septum into the sleeve until the septum is pierced by the needles. Put the bottle retaining clip in place. The valve in the vent line is closed.

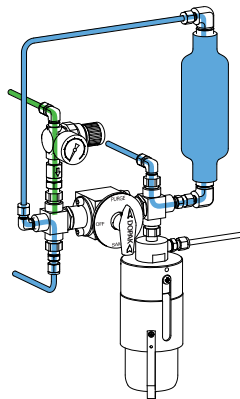

1 - system purge
Turn the handle to the "purge" position, allowing a continuous flow of liquid through the sample chamber to ensure representative sampling. This position can be held for any required time.

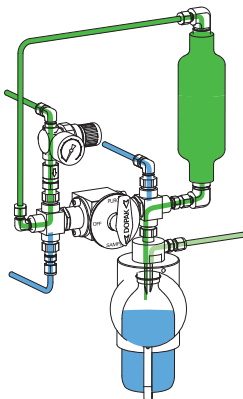

2 - sample
Turn the handle to the "sample" position, allowing the product to flow into the sample bottle. The fixed volume chamber determines the amount of sample. The inert gas will assist the sample to flow into the bottle and will purge the sampler. This position can be held for any required time.

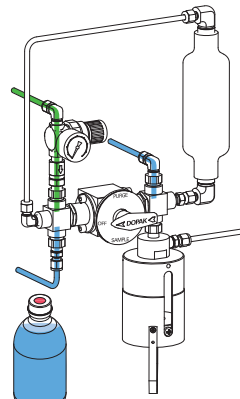

3 - off
Turn the handle to the "off" position. Remove the bottle retaining clip and pull the bottle out from the sleeve. The septum reseals automatically. Put a new bottle in place.

2 TYPICAL P & ID

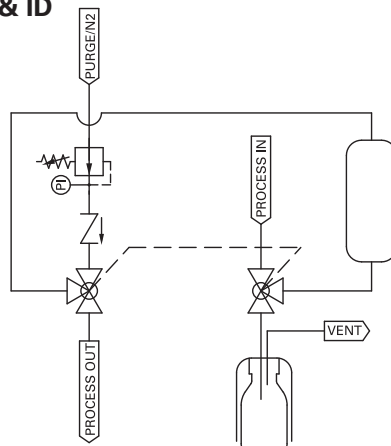

Fixed volume (E5)



3 FEATURES/ADVANTAGES/PROPERTIES

- Sampling independent of process conditions
- High pressure and vacuum applications
- Representative sampling
- Zero dead volume
- Closed sampling
- One handle operation
- Fixed volume sampling
- Purging of sampler

4 BASIC SPECIFICATIONS

Material	SS316, SS316L.
Sleeve type	60cc sleeve with bottle retaining clip.
Needle assembly	Single piece VTO needle assembly with vent to outlet connection 1/4" FNPT. Process/vent needle ID: 1.35 mm.
Sample chamber	50cc.
Valves	Three-way ball valve type W83. PTFE seats, Viton A O-rings. Pressure range 103 bar @ 20°C (1500 psig @ 70°F). Temperature range -17/+232°C (0/+450°F).
Operation	Manual by gearbox.
Connections	1/4" FNPT, regulator, gauge and check valve included.
Please note:	the above is a basic specification only. DOPAK® Samplers can be offered with a wide variety of options as mentioned below.

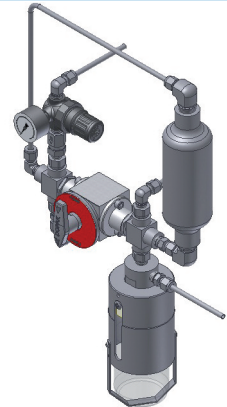

5 OPTIONS

- Spring return handle
- Lockable handle
- Mounting plate
- Pipe stand
- Block valve
- Flow meter
- Enclosure
- Sample cooler
- Mounting bracket
- Steam sterilising cap
- Welded connection
- Continuous needle purge
- Exotic materials
- Larger/smaller sample size

For more information please refer to our sheets:

Options for DOPAK® process samplers, sampling into a bottle.

Components for DOPAK® process samplers.

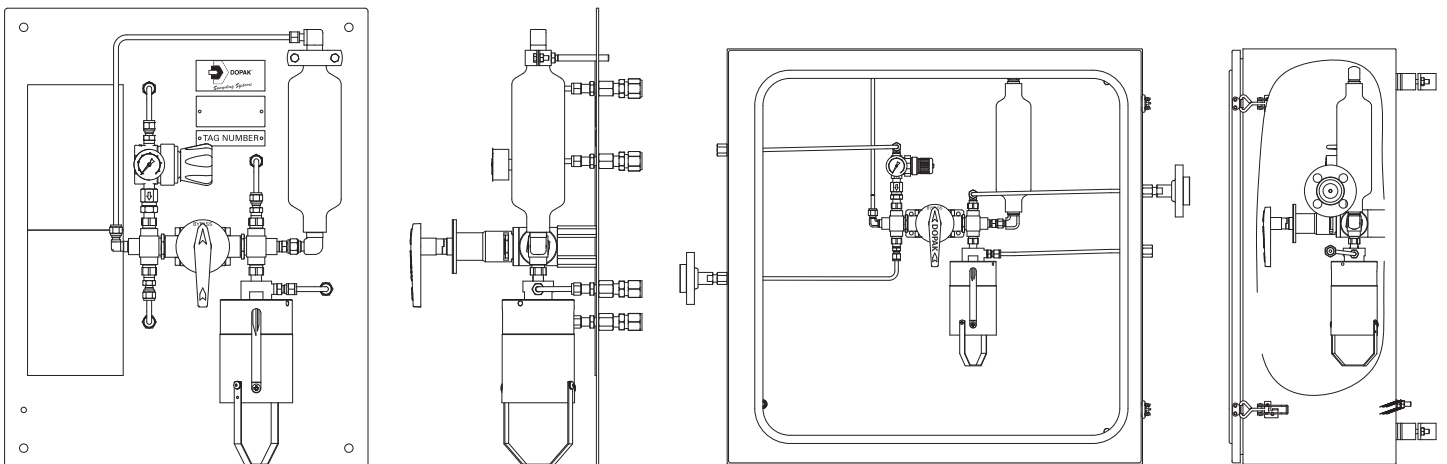

Dopak PFT Corp.

Houston, Texas 77041, USA

Phone 713-460-8311

Fax 713-460-8578

E-mail info-dopak@cranecpe.com

Dovianus BV

Bergschenhoek, The Netherlands

Phone +31 10 524 20 00

Fax +31 10 524 20 29

E-mail info-dovianus@cranecpe.com

Your local distributor

